

OLD WINDMILL

COR NORTH MILL ST & SOUTH MILL ST
NANTUCKET MASSACHUSETTS

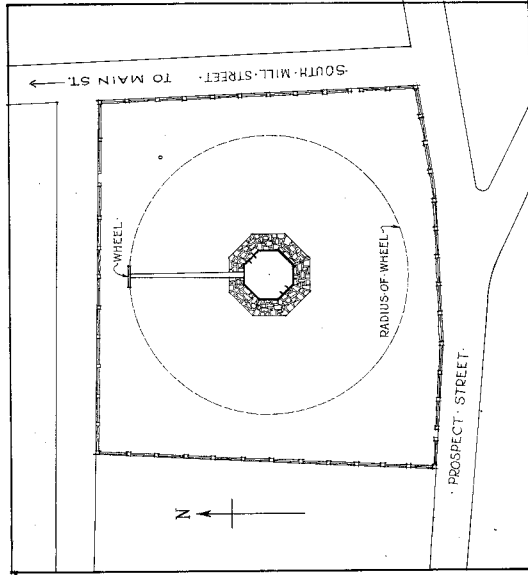

· SKETCH MAP · SHOWING · LOCATION ·

· BUILT · 1746 ·

| | | | | |
|--|---|---|--|---|
| HISTORIC AMERICAN BUILDINGS SURVEY U.S. DEPARTMENT OF THE INTERIOR NATIONAL PARK SERVICE BRANCH OF PLANS AND DESIGN | MEASURED: MAY 26 1934 TO JUNE 12 1934 DRAWN: NOV 26 1934 TO MAY 29 1936 MEASUREMENTS CHECKED: O. WILLAUER | DRAWINGS APPROVED: <i>Frank Chouteau Brown</i> DISTRICT OFFICER: DRAWINGS APPROVED: <i>S. L. C. Hunt</i> CHIEF ARCHITECT: ACCEPTED FOR LIBRARY OF CONGRESS: | DISTRICT NO. 2 MASSACHUSETTS FRANK CHOUTEAU BROWN ARCHITECT BOSTON OFFICE MASSACHUSETTS FIELD MEASUREMENTS BY FRANK CHOUTEAU BROWN 16 BRIMMIE ST. BOSTON MASS. | SURVEY NO. MASS. 141 INDEX NO. MASS. 10-NANT 5 SHEETS |
|--|---|---|--|---|

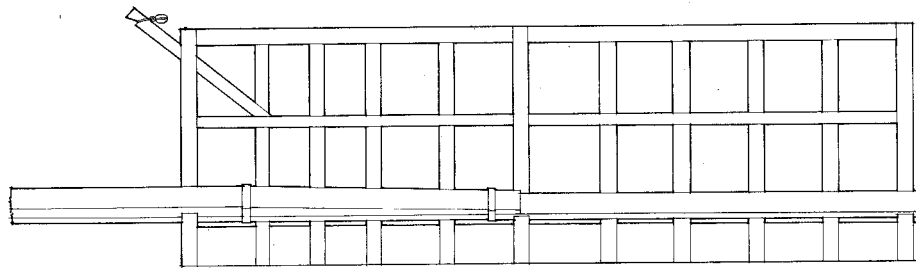

INSIDE ELEVATION
OF WIND VANE



SECTION THRU VANE

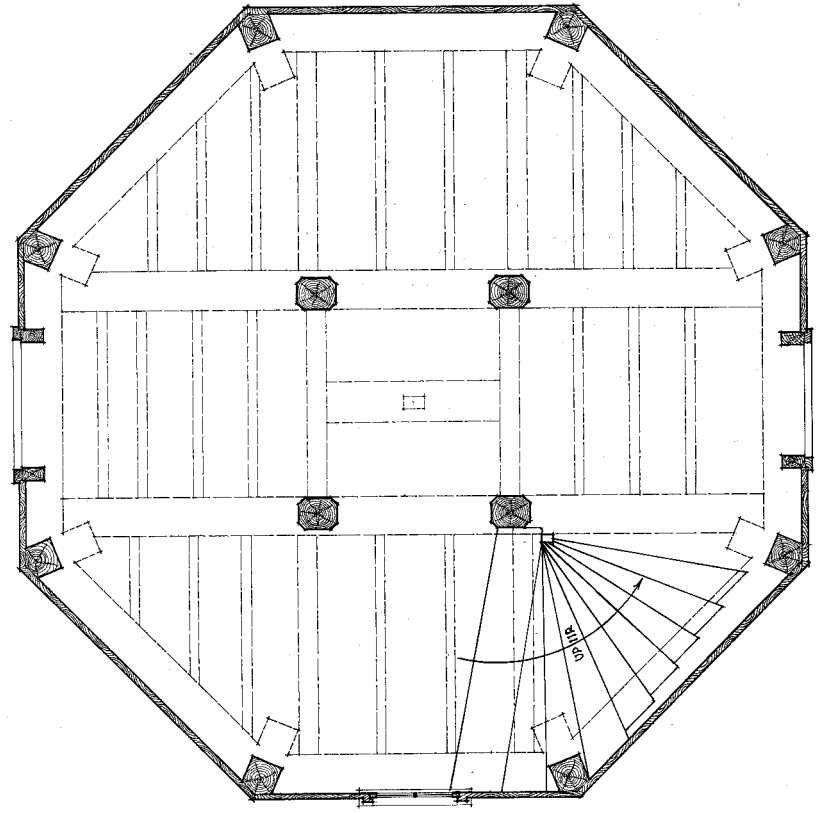

GROUND FLOOR PLAN

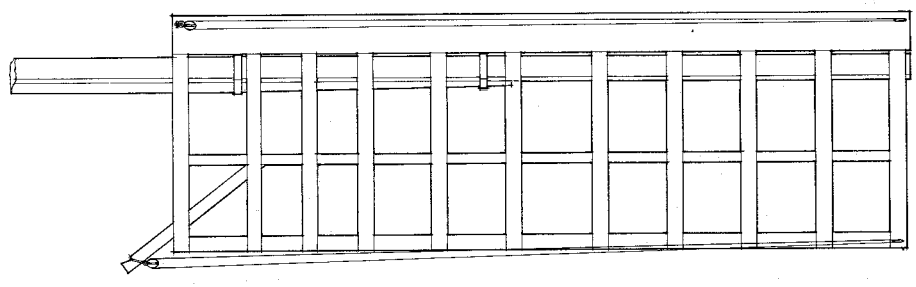

OUTSIDE ELEVATION
OF WIND VANE

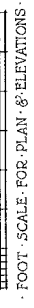
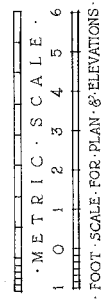

WORK DONE WITH
MASS. P. & A. FUNDS
JOHN E. LINNETT-DEL.

U.S. DEPARTMENT OF THE INTERIOR
OFFICE OF NATIONAL PARKS, BUILDINGS AND RESERVATIONS
BRANCH OF PLANS AND DESIGN

NAME OF STRUCTURE

OLD WINDMILL - NANTUCKET - NANTUCKET COUNTY - MASS.

BUILT 1746

SURVEY NO.
MASS.
141

HISTORIC AMERICAN
BUILDINGS SURVEY
SHEET 1 OF 5

INDEX NO.

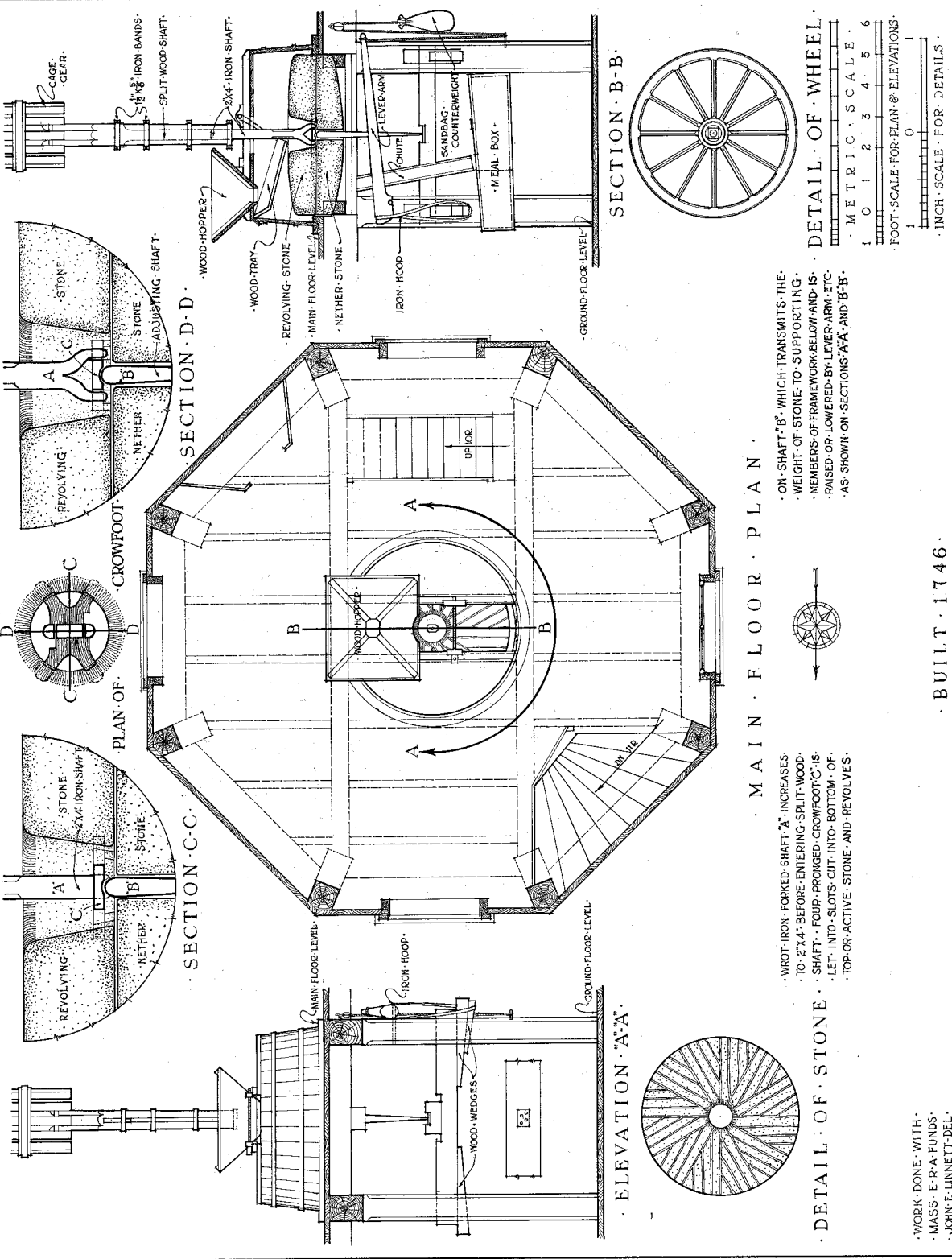

· MAIN FLOOR PLAN ·

- ON-SHAFT "B" WHICH TRANSMITS THE WEIGHT OF STONE TO SUPPORTING MEMBERS OF FRAMEWORK BELOW AND IS RAISED OR LOWERED BY LEVER ARM, ETC.
- AS SHOWN ON SECTIONS "A-A" AND "B-B".

- WROTE IRON FORKED SHAFT "A" INCREASES TO 2"x4" BEFORE ENTERING SPLIT WOOD-SHAFT.
- SPLIT WOOD-SHAFT PRONGED CROWFOOT "C" IS LET INTO SLOTS CUT INTO BOTTOM OF TOP OR ACTIVE STONE AND REVOLVES.

· DETAIL OF STONE ·

- WORK DONE WITH MASS E.P.A. FUNDS ·
- JOHN E. LINNETT-DEL. ·

· DETAIL OF WHEEL ·

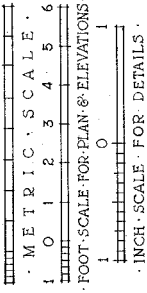

· FOOT SCALE FOR PLAN & ELEVATIONS ·

· BUILT · 1746 ·

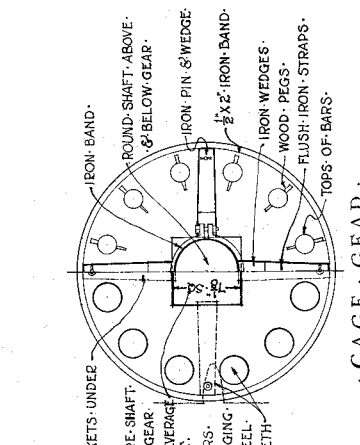
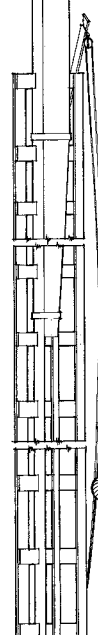
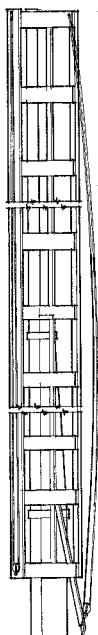

CAGE GEAR

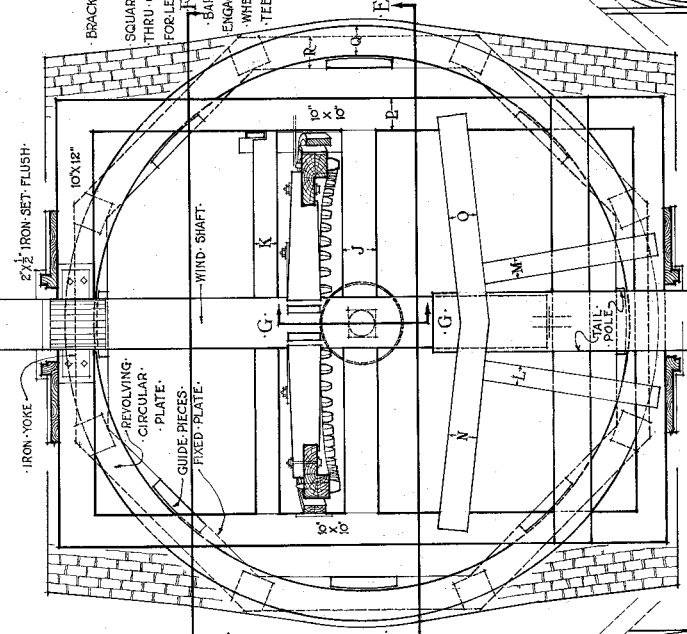

THIRD FLOOR PLAN

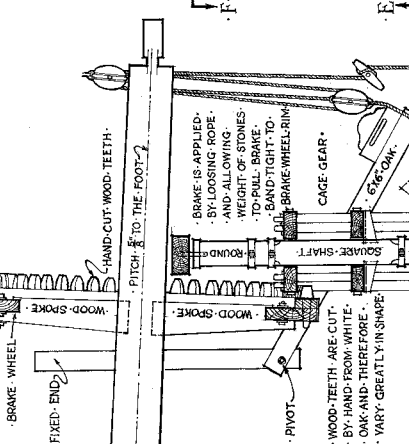

BRAKE DETAIL G-G

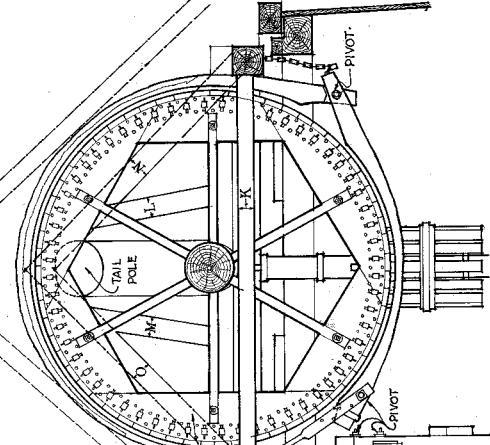

SECTION F-F

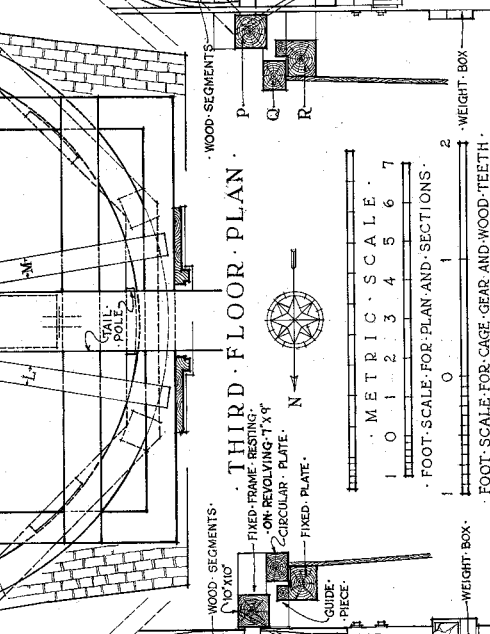

SECTION E-E

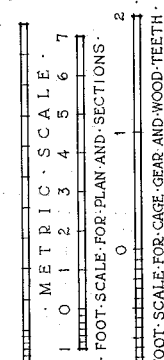

WORK DONE WITH MASS. E. R. A. FUNDS JOHN E. LINNETT-DEL.

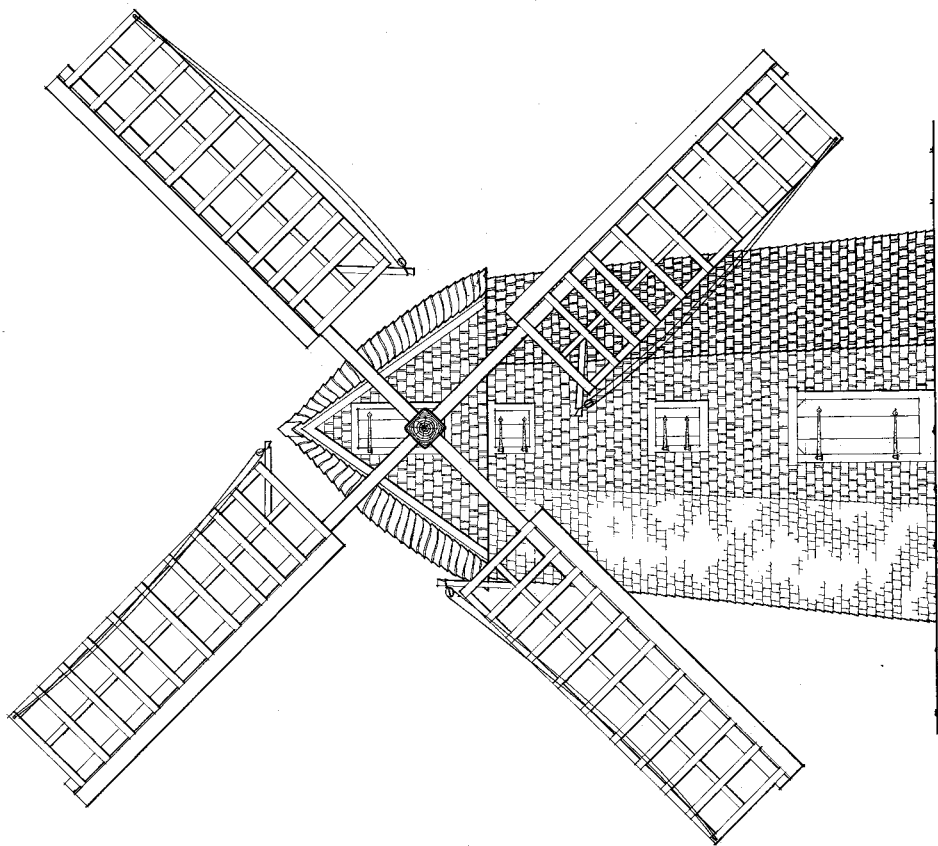

· EAST · ELEVATION ·

· BUILT · 1746 ·

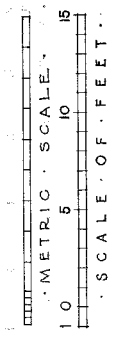

· WORK · DONE · WITH ·
 · MASS · E · R · A · FUNDS ·
 · JOHN · LINNETT · DEL ·

U.S. DEPARTMENT OF THE INTERIOR
 OFFICE OF NATIONAL PARKS, BUILDINGS AND RESERVATIONS
 BRANCH OF PLANS AND DESIGN

· OLD · WINDMILL · NANTUCKET · NANTUCKET COUNTY · MASS ·

SURVEY NO.
 · MASS ·
 · 141 ·

HISTORIC AMERICAN
 BUILDINGS SURVEY
 SHEET 4 OF 5 SHEETS

INDEX NO.

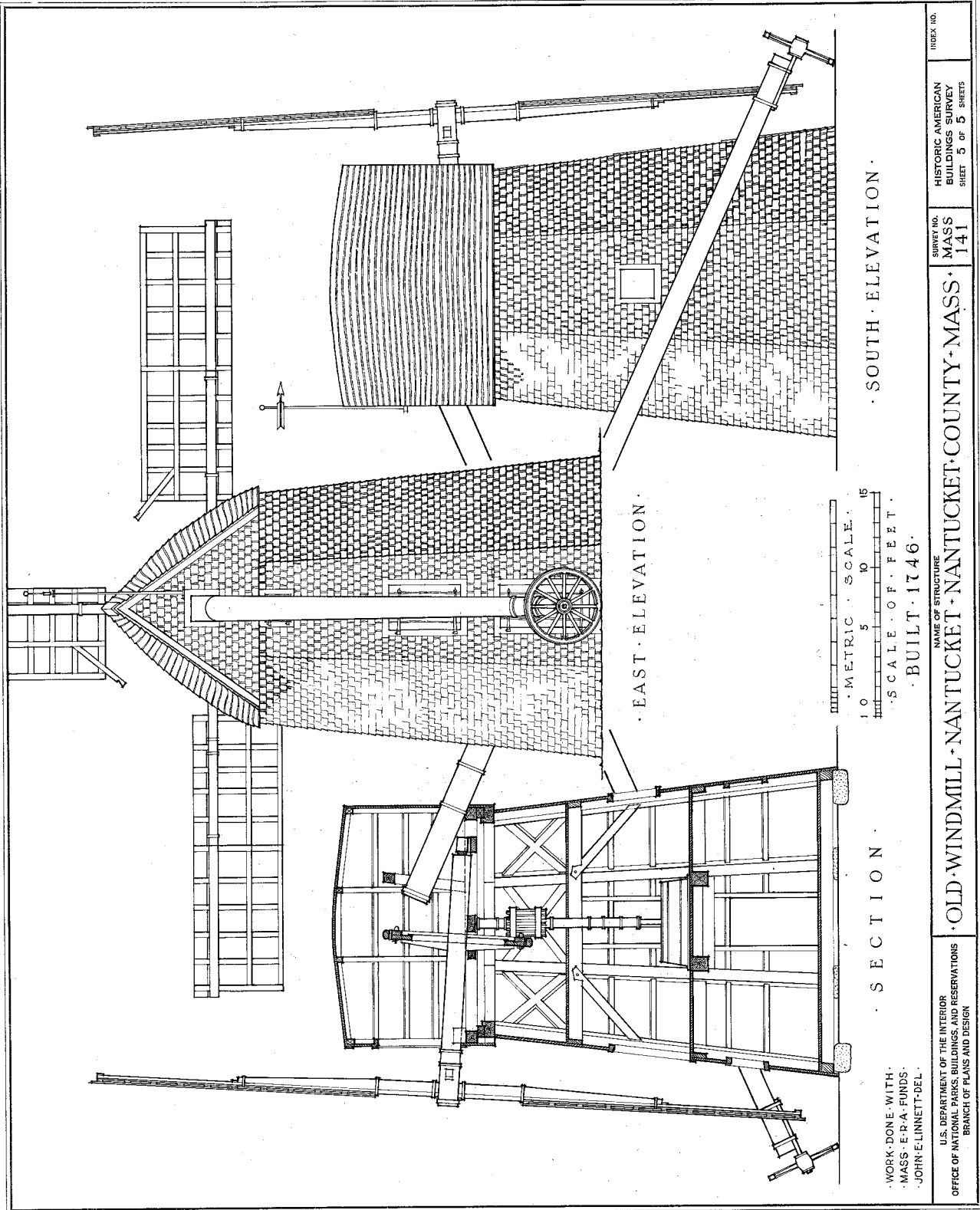

·WORK DONE WITH·
 ·MASS·ERA·FUNDS·
 ·JOHN·E·LINNETT·DEL·

U.S. DEPARTMENT OF THE INTERIOR
 OFFICE OF NATIONAL PARKS, BUILDINGS, AND RESERVATIONS
 BRANCH OF PLANS AND DESIGN

NAME OF STRUCTURE

·OLD·WINDMILL·NANTUCKET·NANTUCKET·COUNTY·MASS·

SURVEY NO.

MASS
 141

INDEX NO.

HISTORIC AMERICAN
 BUILDINGS SURVEY
 SHEET 5 OF 5 SHEETS

· SOUTH ELEVATION ·

· SECTION ·

· EAST ELEVATION ·